

REVISION RECORD			
REV.	CONTENT	MOD.	DATE
△	初版发行		

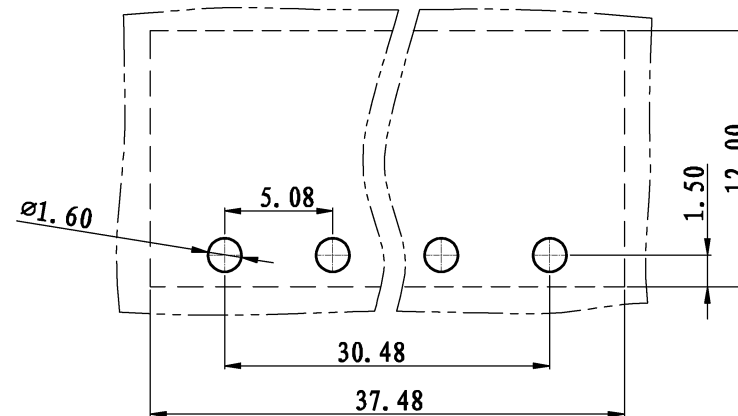

NOTES:
 Pitch : 5.08mm
 Rated Voltage: 300V
 Rated Current: 15A
 Withstand Voltage :
 AC2500V for 1 minute
 Insulation Resistance :
 1000MΩ / DC1000V
 Using Temperature Range :
 - 40℃ ~ + 105℃
 Flame retardant rating:
 V0

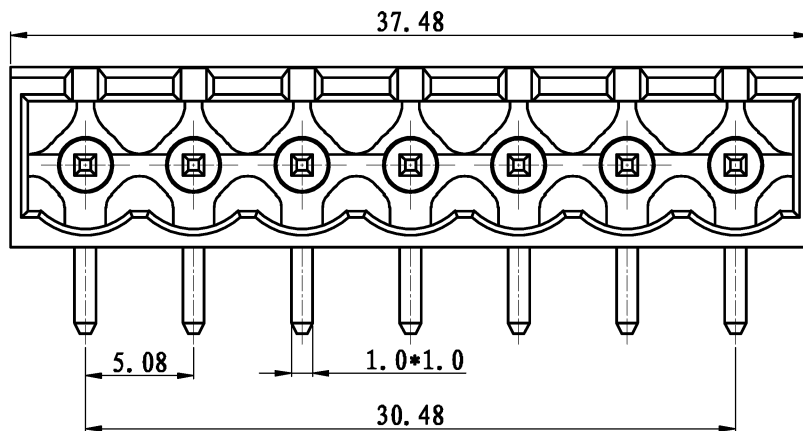
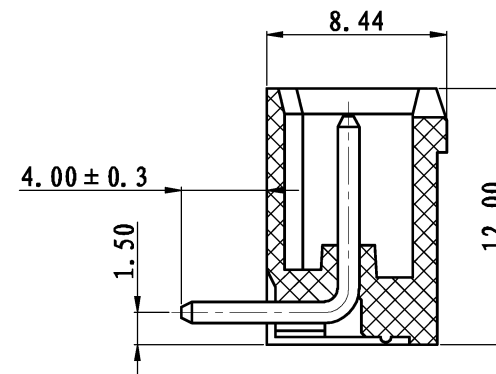
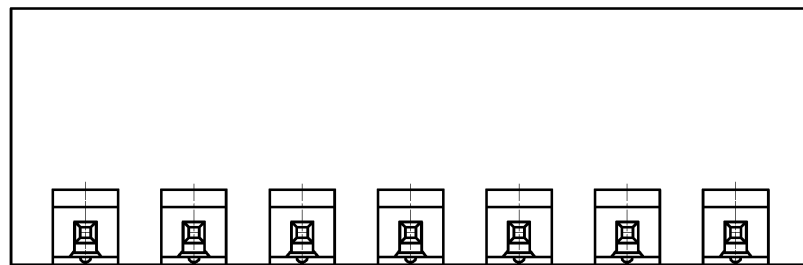

技术要求:
 间距: 5.08mm
 额定电压: 300V
 额定电流: 15A
 耐电压值: AC2500V/min
 绝缘阻抗: 1000MΩ/DC1000V
 使用条件: -40℃~+105℃
 阻燃等级: V0

	pitch dimension			Nominal dimension					—
	over	over	over	over	over	over	over	over	
variable range	0	6	10	0	30	60	100	150	□
	to	to	to	to	to	to	to		
Tolerance	±0.1	±0.15	±0.25	±0.2	±0.3	±0.5	±0.7	±1.0	0.05/10

2	LZ1-5.08-弯针	1015B0001AV	P	黄铜	镀雾锡
1	LZ1-5.08-本体	1015A0YXXAV	1	PA66	
NO.	NAME OF PART	NO. OF PART	Q' TY	MATERIAL	NOTES
DES.	ARKINE	DATE	2010/5/20	UNITS	MM
CHK.		DATE		SIZE	A4
APP.		DATE		SCALE	1:1
				DWG NO.	SP-2-1015002
				REV:	T0
 上海联捷电气有限公司 Shanghai Blinker Electric C.O.,LTD				TITLE	LZ1R-5.08-7P-1Y-00A
					LZ1R-5.08-成品